

GC90

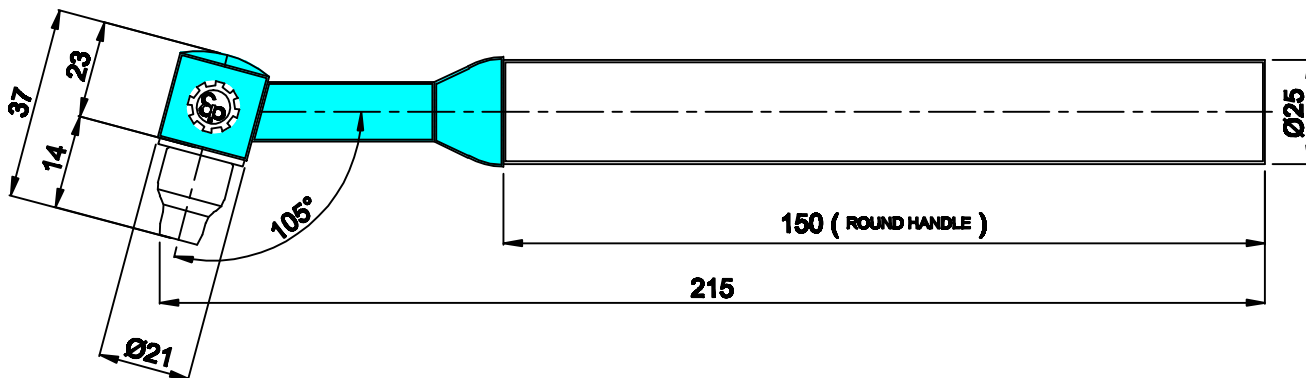

NOTE : 1) ALL DIMENSIONS ARE IN MM 2) HEAD LENGTH WILL VARY AS PER LENGTH OF ARGON ARC NOZZLE

IN VIEW OF CONTINUOUS DEVELOPMENT , WE RESERVE THE RIGHT TO MODIFY THE DESIGN AND/OR DIMENSIONS WITHOUT NOTICE.

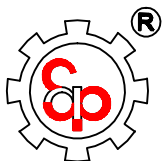

GC90

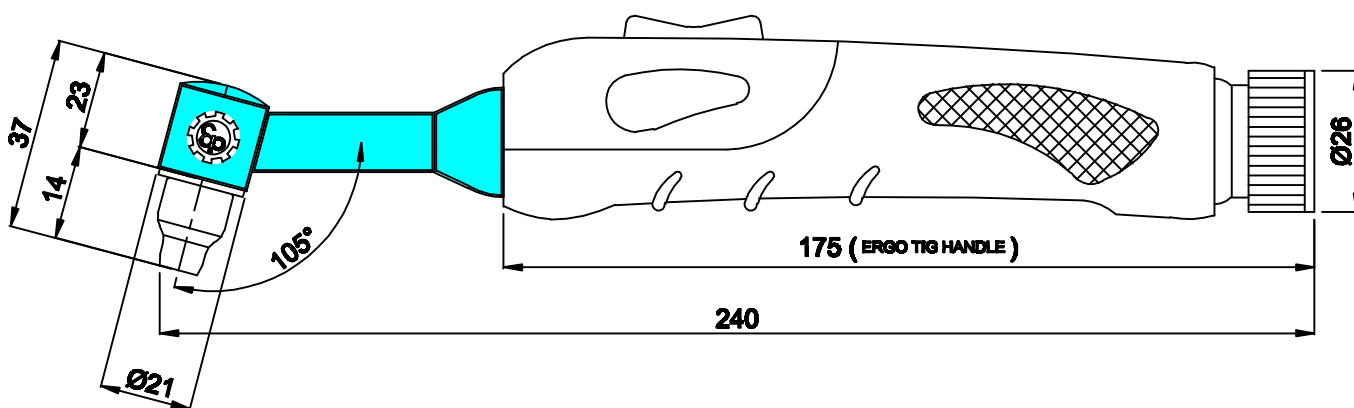

NOTE : 1) ALL DIMENSIONS ARE IN MM 2) HEAD LENGTH WILL VARY AS PER LENGTH OF ARGON ARC NOZZLE

IN VIEW OF CONTINUOUS DEVELOPMENT , WE RESERVE THE RIGHT TO MODIFY THE DESIGN AND/OR DIMENSIONS WITHOUT NOTICE.